

Catalogue sheet

Anchor wedge clamp including pin For wire 95 - 120mm²

Order number: 0009.2

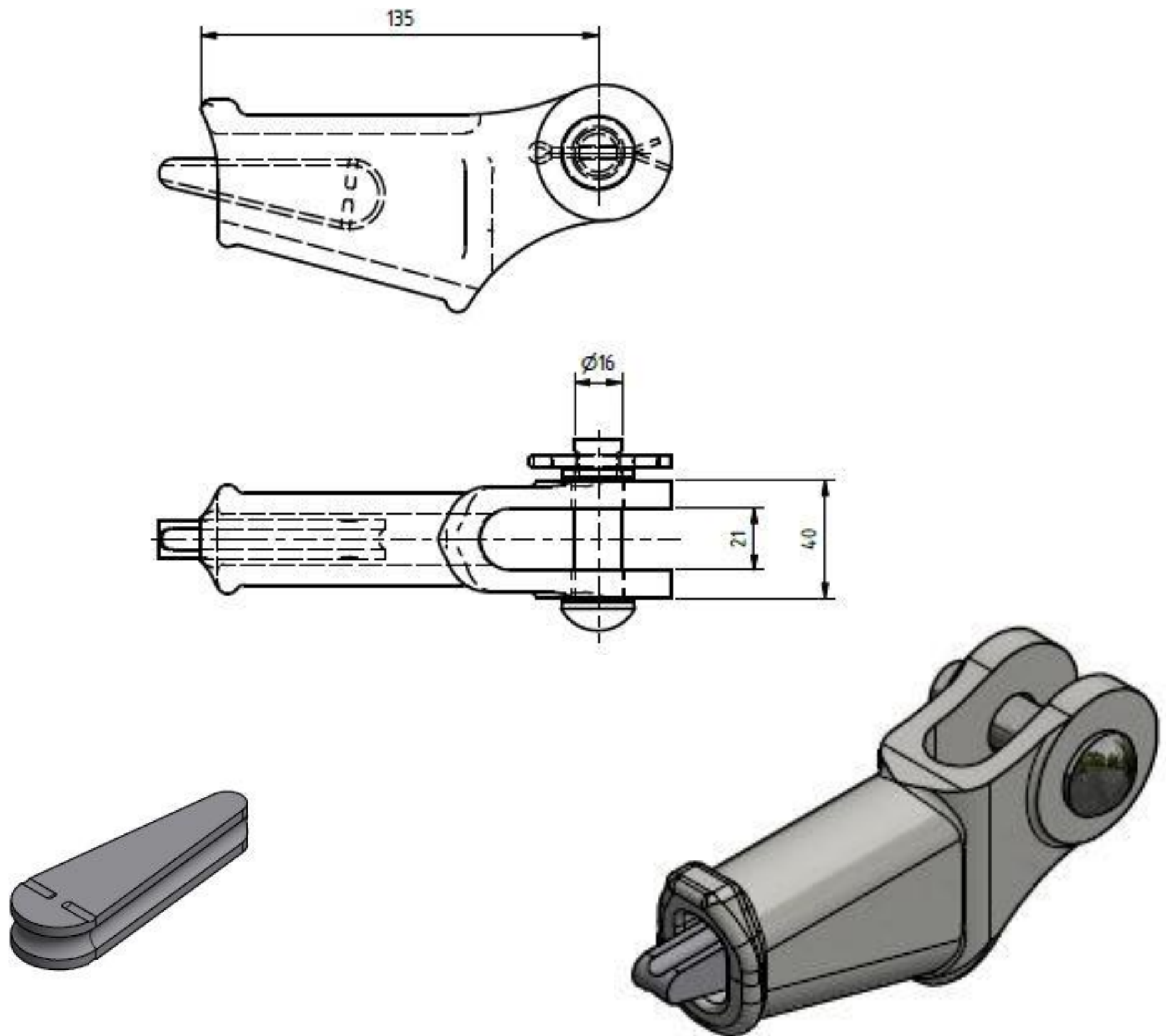

Technical parameters

- Material: FeZn cast iron, A2, Cu split pin
- Weight: 1,14 kg (2,5 lb)
- Max. load: 20 kN
- Including: pin, washer, split pin and wedge

Esko spol. s r.o.

Praha 5, Jinonická 80, 15800 CZ
IČO: 60471999
DIČ: CZ60471999

Email: info@esko-praha.cz
Phone: +420257290280
www.esko-praha.cz