

Catalogue sheet

Current clamp for wire 50 – 185 mm² (0,077 in² - 0,287 in²)

Order number: 0077.3

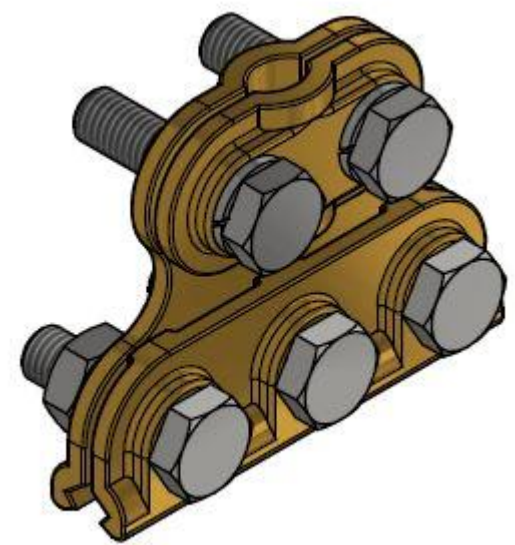
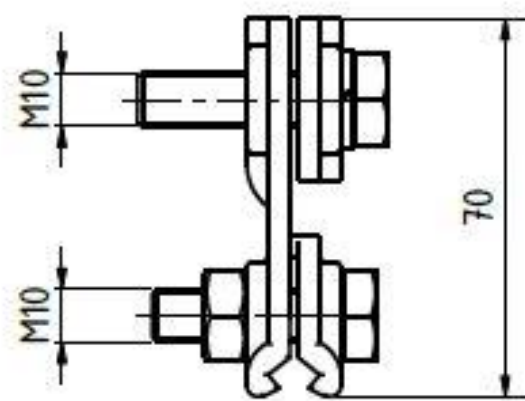
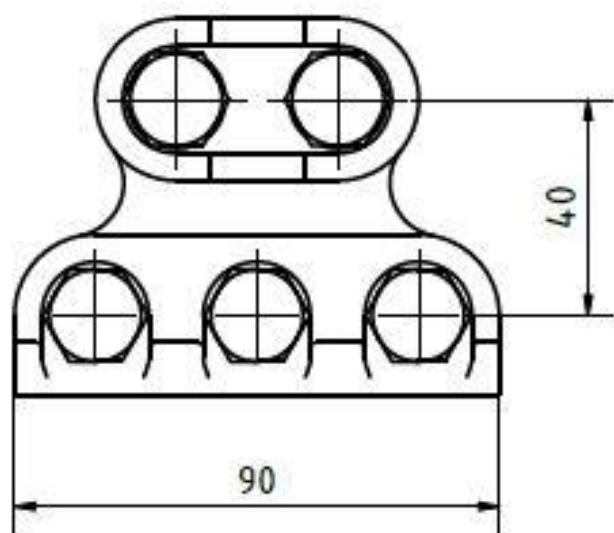

Technical parameters

- Material: Brass, A2
- Weight: 0,37kg (0,82 lb)
- Max. screw tightening torque: 35 Nm (25,8 ft-lbs)

Esko spol. s r.o.

Praha 5, Jinonická 80, 15800 CZ

IČO: 60471999

DIČ: CZ60471999

Email: info@esko-praha.cz

Phone: +420257290280

www.esko-praha.cz