

Catalogue sheet

Catenary ending clamp for wire 150 mm² (0,232 in²)

Order number: 0133.2

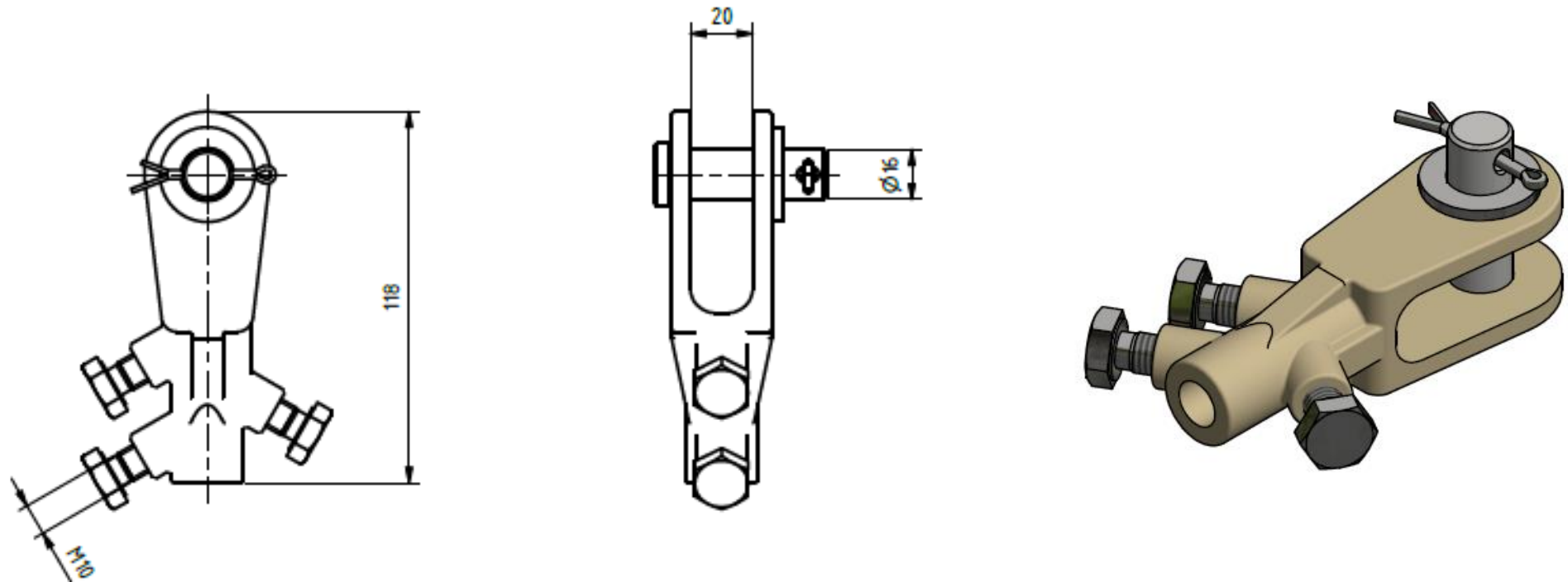

Technical parameters

- Material: Bz, A2, Cu
- Weight: 0,41 kg (0,9 lb)
- Max. allowable load: 10 kN
- Max. tightening torque: 40 Nm (29,5 ft.lb)

Esko spol. s r.o.

Praha 5, Jinonická 80, 15800 CZ
IČO: 60471999
DIČ: CZ60471999

Email: info@esko-praha.cz
Phone: +420257290280
www.esko-praha.cz